



Color Filters, A08070-A08074

A08931
Color Filter
AdapterA08087 & A08086
Input Lens Diffusers

Spot lens models, A08080, A08084, A08082

Polarizing cap, A08090, for spot lens,
A08080

Filters, Diffusers & Spot Lenses

Filters and Adapter

- Available in red, green, blue, yellow, and daylight. These Dichroic filters will not darken or alter spectral response over time, regardless of light intensity or duration. The daylight filter increases existing color temperature to approximately 3000 K when used with EKE, EJA, and DDL lamps at their rated voltages.
- Dichroic color filters reflect heat versus absorbing it, eliminating the need for a thermal expansion split.
- Clear anodized aluminum housing is used on the filters. Black anodized aluminum housing is used on the adapter.

Diffusers

- Input lens diffuser, part number, A08086, homogenises beam with minimal light loss and minimizes black hole phenomenon from fiber bundles.
- Opal diffuser option, part number, A08087, creates the most uniform light - almost flat illumination, but reduces output by 40%.
- Diffusers fit on all ColdVision standard inputs.

Spot Lenses

- Used on distal ends of goosenecks and bundles to focus the light.

Part No.	First Spot Location	First Spot Diameter	Second Spot Location	Second Spot Diameter
A08080	40 mm	45 mm	80 mm	90 mm
A08082	40 mm	30 mm	80 mm	60 mm
A08084	40 mm	30 mm	80 mm	60 mm

- Polarizing cap, part number, A08090, is available for spot lens model, A08080, to eliminate glare and reflections. Five spare polarizing discs are included with the product.

Filters, Diffusers & Spot Lenses

Part No. Description

Dichroic Color Filters & Adapter

A08070	Blue	A08073	Red	A08931	Color Filter Adapter
A08071	Green	A08074	Daylight		
A08072	Yellow	A08075	UV Filter, Cut-off		

Diffusers

A08086	Input lens diffuser
A08087	Input opal diffuser

Spot Lenses

A08080	Spot lens for std. bundles except A08051.40 & A08051.60
A08082	Small spot lens for std. bundles except A08051.40 & A08051.60
A08084	Spot lens for models A08051.40 & A08051.60

Polarizing Cap (for A08080)

A08090	Polarizing cap for A08080 (fits on A08575)
--------	--

Filters, Diffusers & Spot Lenses

Dimensions in () are in mm

Product improvements may result in specification or feature changes without notice.

A08070 - A08074

Dichroic Color Filters

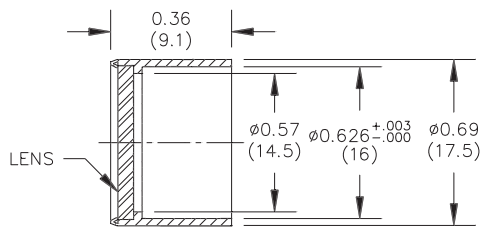

LENSES:
 A08070 = BLUE
 A08071 = GREEN
 A08072 = YELLOW
 A08073 = RED
 A08074 = DAYLIGHT

A08086

Input Lens Diffuser

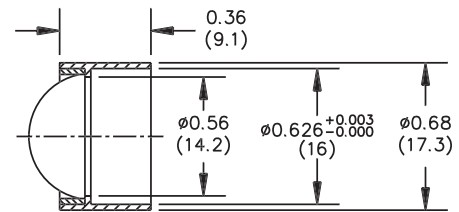

A08931

Color Filter Adapter

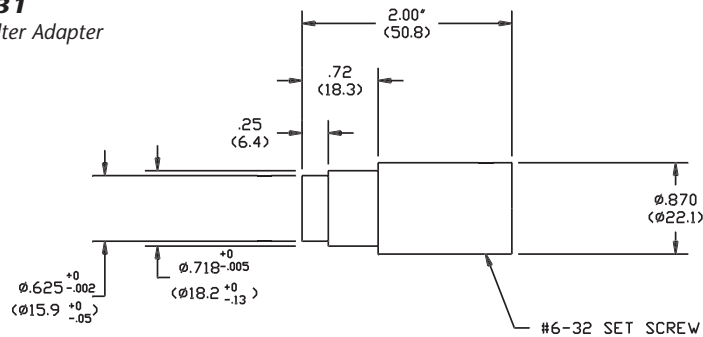

A08087

Input Opal Diffuser

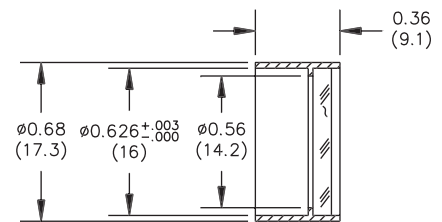

A08080

Spot Lens

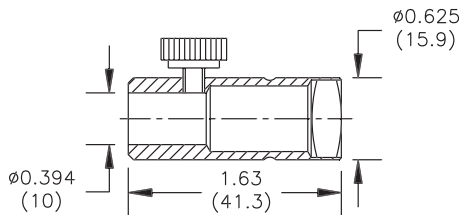

A08082

Small Spot Lens

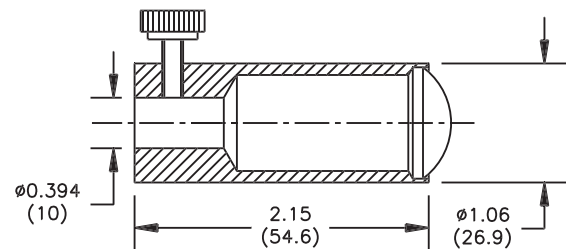

A08084

Spot Lens

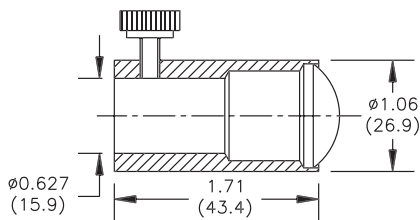

A08090

Polarizing Cap

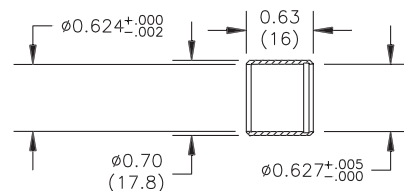

Lighting and Imaging

SCHOTT North America, Inc.

122 Charlton Street

Southbridge, MA 01550

USA

Phone: +1 508/765-9744

Fax: +1 508/764-6273

E-mail: lightingimaging@us.schott.com

www.us.schott.com/lightingimaging

SCHOTT
 glass made of ideas